

STRAWBERRY

by Rae Cooker

Use 2 squares the same size, one red and one green.
Fold 2 squares alike but separately through step 7.

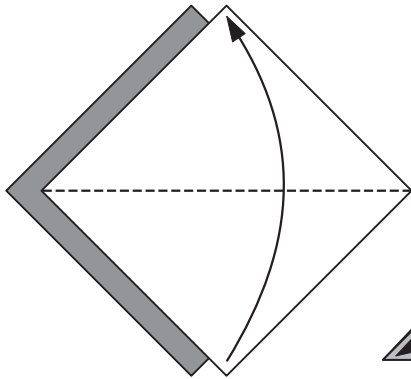

1. Red, color side up.
Green, white side up.
Fold in half.

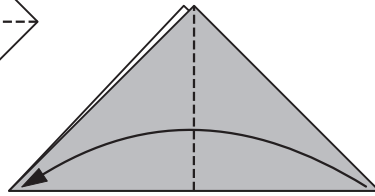

2. Fold in half.

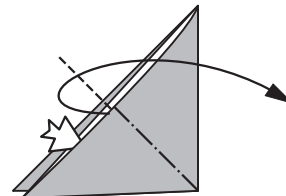

3. Squash to the right.

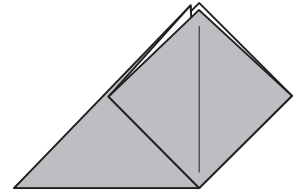

4. Turn it over.

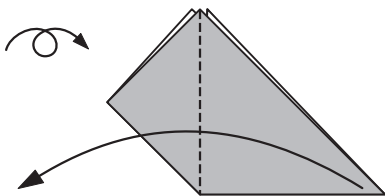

5. Fold one flap to the left.

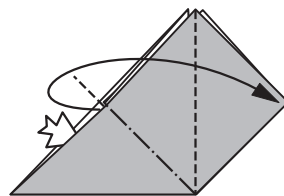

6. Squash to the right.

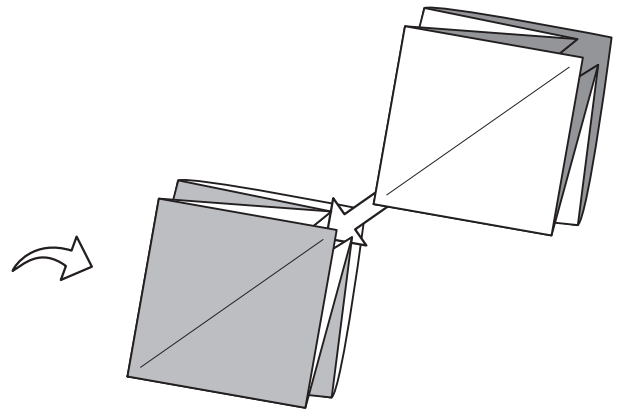

7. Fit green piece inside red one.
From here, fold as one.
Press flat with 2 flaps on each side.

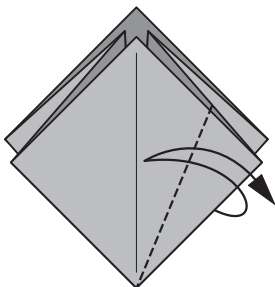

8. Fold edge to center crease. Unfold.

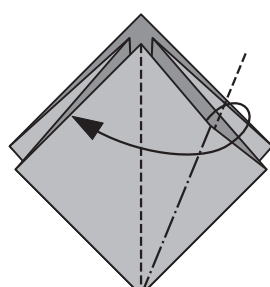

9. Lift one flap. Separate the 2 layers and press the edge fold until it is squashed flat right over the center line where the folded edges of the flaps below meet.

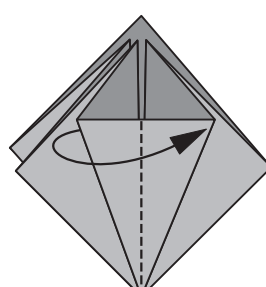

10. Fold one flap only.

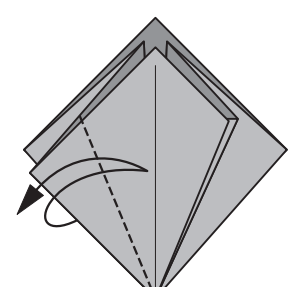

11. Repeat step 8-9.
Turn it over, repeat step 8-10.

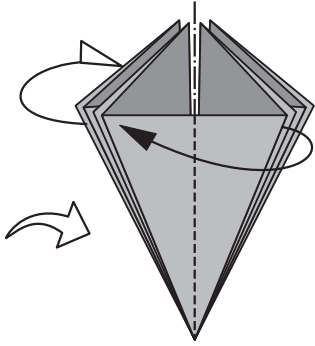

12. your model now has 8 flaps which can be turned like pages of a book. Turn "pages" until you have a kite-shaped surface of one color with 4 flaps on each side.

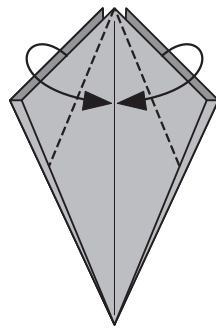

13. Fold in the short cut edges to the center fold.

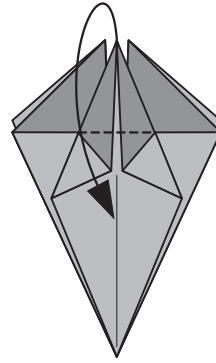

14. Fold down the top point of the leaflet you have formed in step 13.

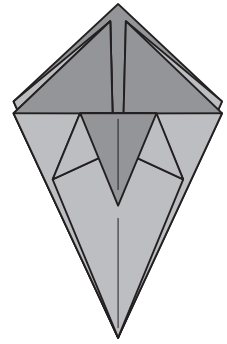

15. Completed step 14. Turn it over. Repeat step 13-14.

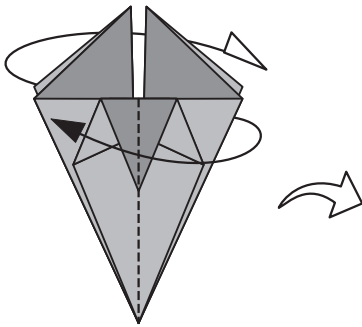

16. Turn 2 "Pages" to one color surface. Repeat 13-15.

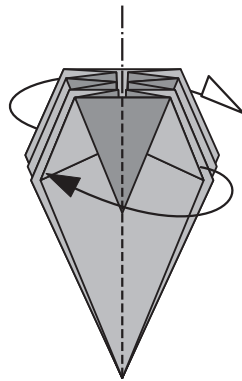

17. Turn 1 "Page" in front and back.

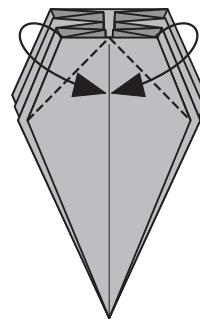

18. Bring top corners to center line. Turn over. Repeat.

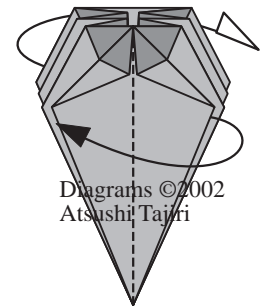

19. Turn 2 "pages" in the front. Turn 2 "pages" in the back. Model is again one color front and back.

Diagrams ©2002
Atsushi Tajiri

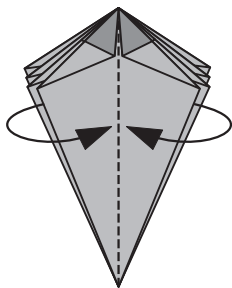

20. Bring neighboring flaps together in pairs exposing leaflet.

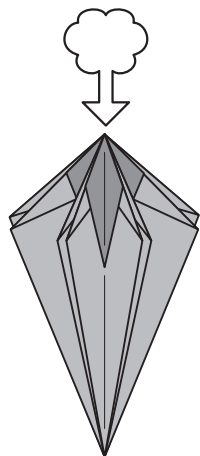

21. Folding complete. Ready to inflate.

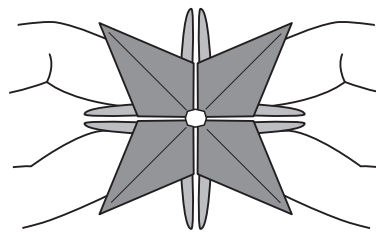

22. For hanging as an ornament, put loop of thread through button. Put button inside strawberry before inflating.

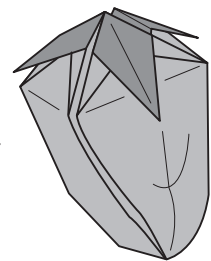

23. Finished strawberry! Shape to taste.