

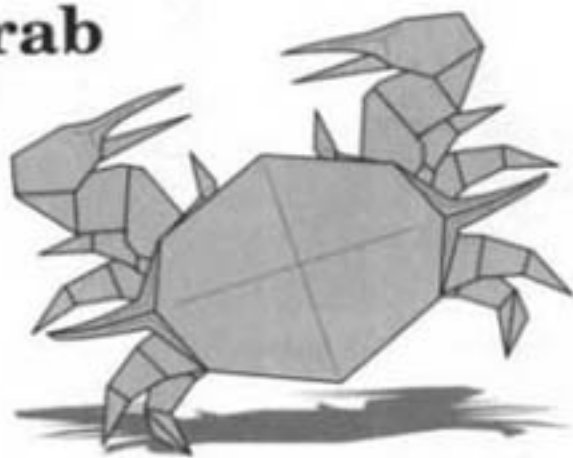

# Blue Crab

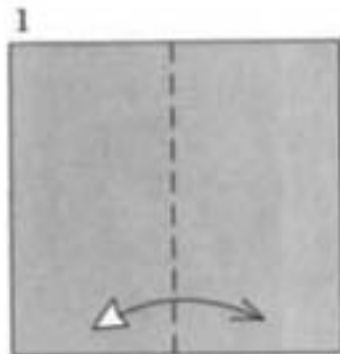

The Blue Crab (*Callinectes sapidus*) is a commercially important species that supports a fishing industry in Chesapeake Bay and all along the Atlantic and Gulf coasts. This species has been overexploited through the years and its numbers have been greatly reduced, but the population has now stabilized due to many fishing restrictions on size, sex, and season for harvest. Some fish farms are even experimenting to see if there is a practical method of culturing them. Blue crabs can get to be 5 or 6 inches across and have a hard shell that is blue above and white below. Immediately after molting, however, the shell is soft and papery, and they are sold (and devoured) as "soft-shell crab."



Fold the paper in half and unfold.

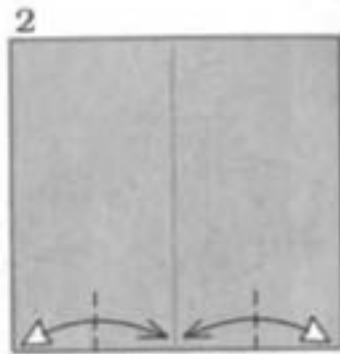

Fold the edges to the center, crease, and unfold.

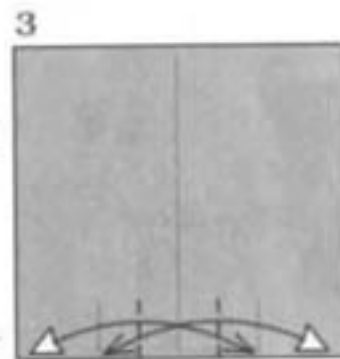

Fold and unfold.

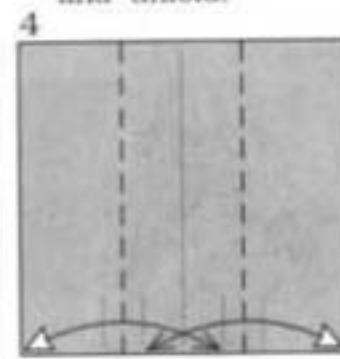

Fold and unfold.

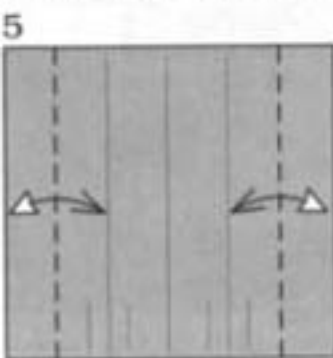

Fold and unfold.

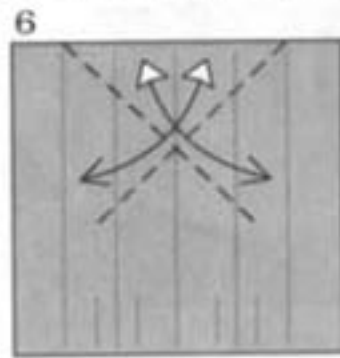

Fold and unfold.

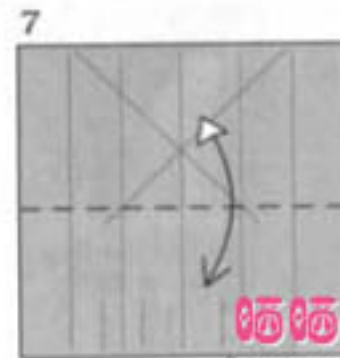

Fold and unfold.

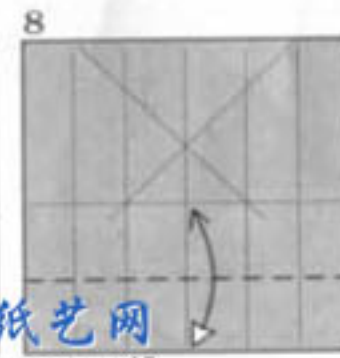

Fold and unfold.

晒晒纸艺网

(www.saysay.net)

9

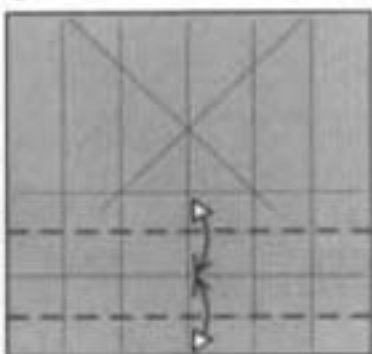

Fold and unfold.

10

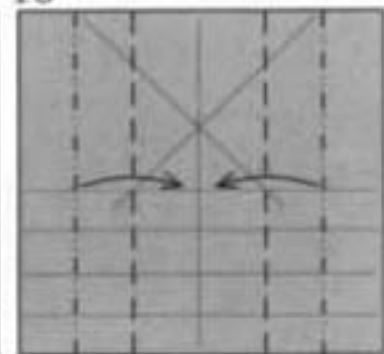

Pleat on existing creases.

11

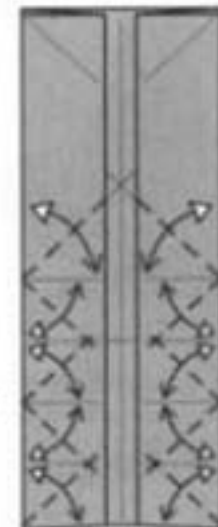

Fold and unfold.

12

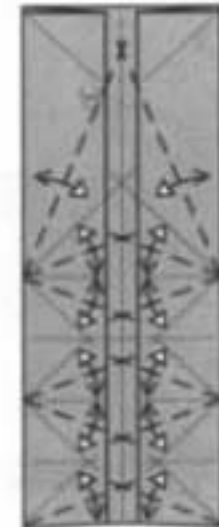

Fold and unfold.

13

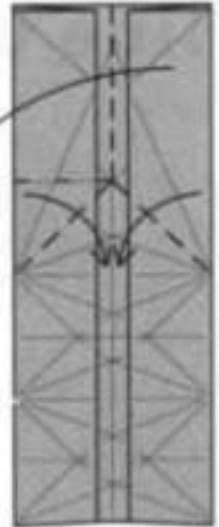

Fold a rabbit ear from the top of the paper.

14

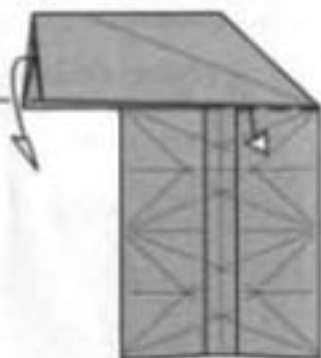

Fold a double layer of paper down from inside the rabbit ear.

15

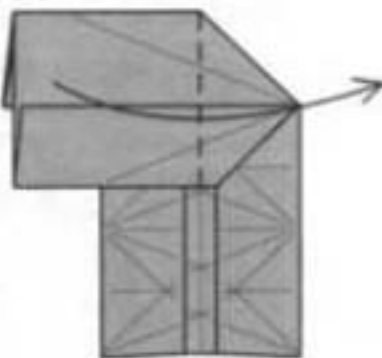

Fold the flap to the right.

16

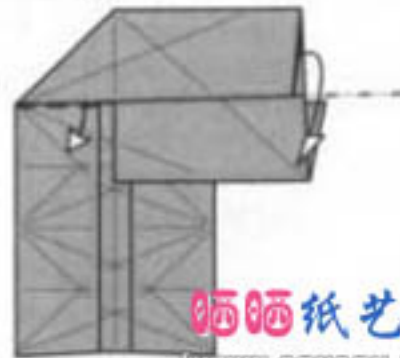

Repeat step 14.

17

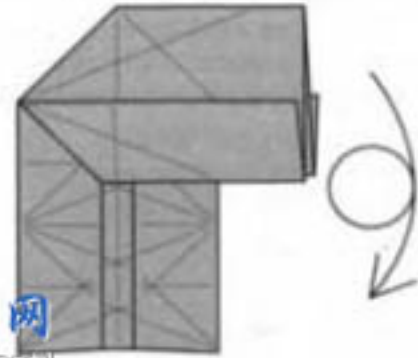

Like this. Turn the paper over from top to bottom.

晒晒纸艺网  
[www.saysay.net]

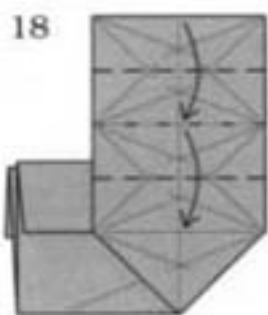

Pleat on existing creases.

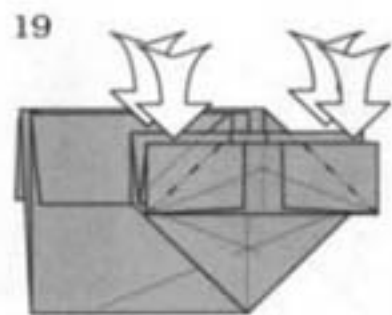

Reverse-fold four corners.

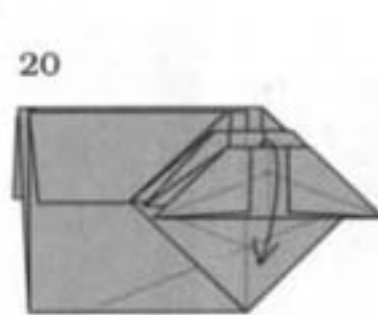

Fold one flap down.

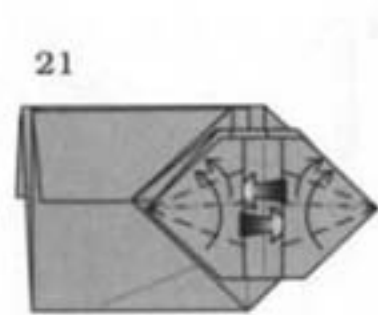

Fold it back up, incorporating the reverse folds shown.

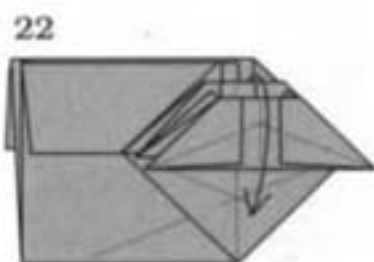

Fold two flaps down.

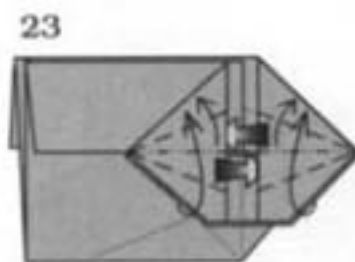

Fold them back up, incorporating the reverse folds shown.

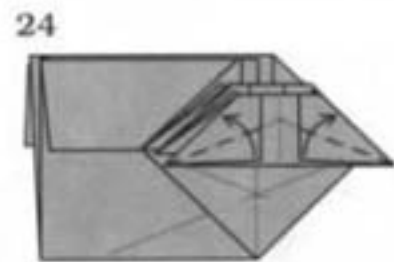

Valley-fold the flaps upward.

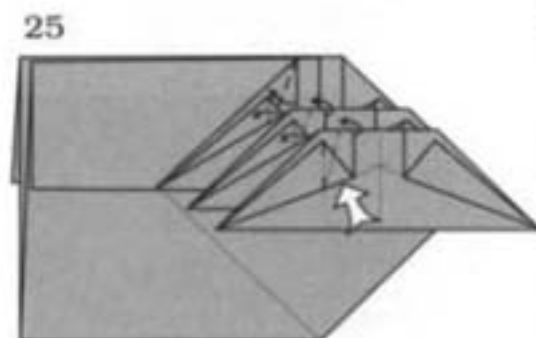

Reverse-fold all the layers on the left side of the pleats.

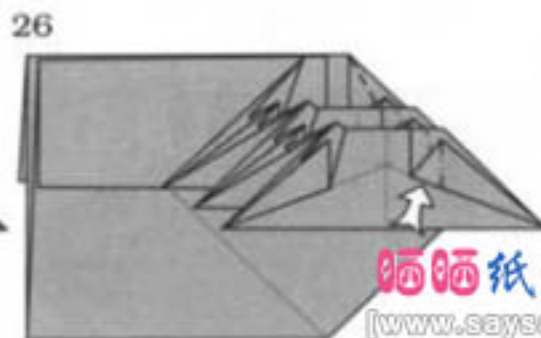

Reverse-fold the layers on the right.

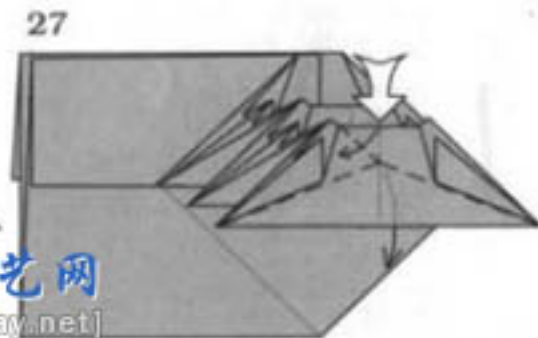

Push the middle of the top pleat down, making the small vertical pleat in the middle. The paper will not lie flat.

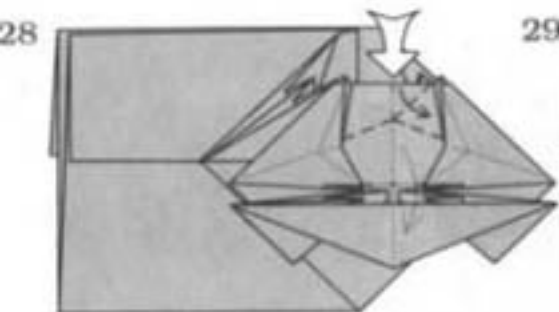

Repeat on the other pleat.

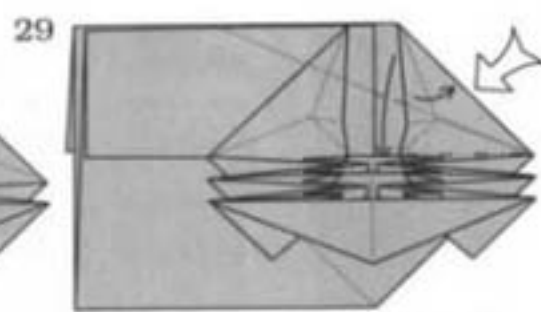

Reverse-fold the right edge and reassemble the creases that came unfolded in the previous step.

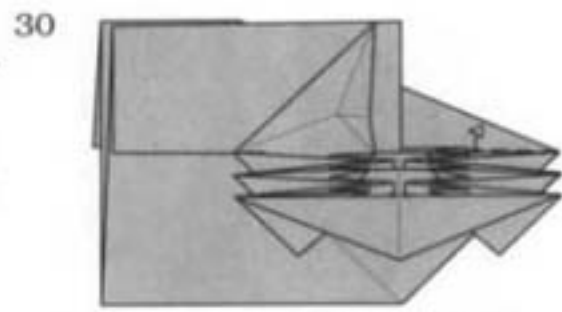

Pull out a single layer of paper from the double thickness rabbit ear to make it symmetric about a horizontal axis.

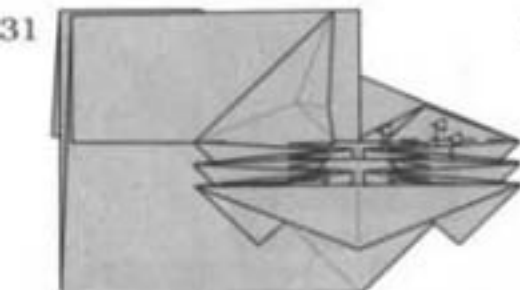

Again, pull out a single layer from the double thickness.

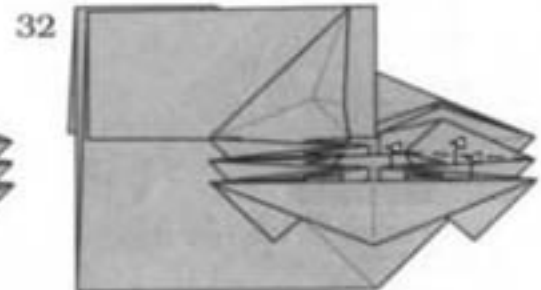

Again.

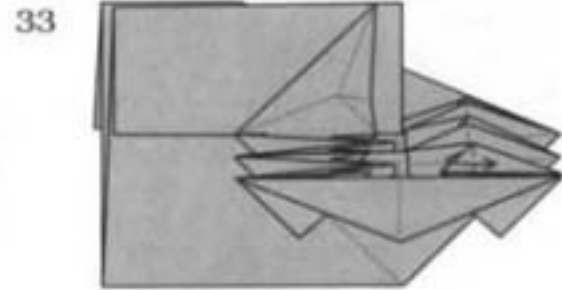

Fold the small flap over to the right.

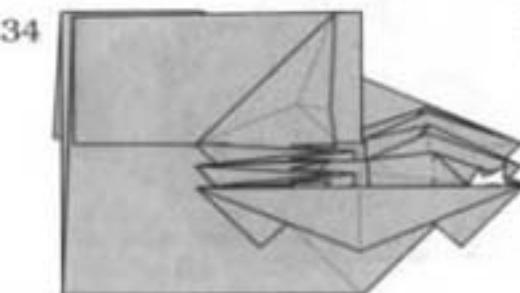

Sink the point into the interior of the model.

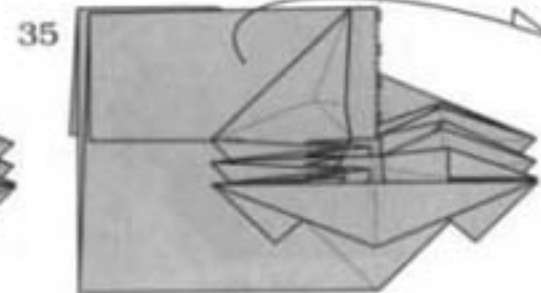

Fold the large flap over to the right.

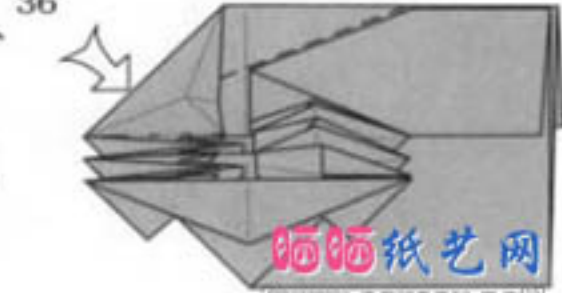

Repeat steps 29-34 on the left.

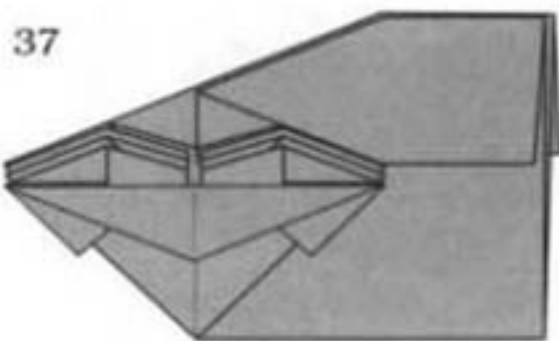

Like this. Turn the paper over.

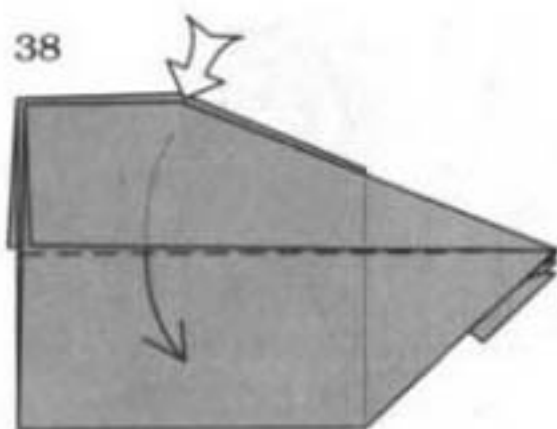

Fold the top flap down while sinking it inside-out.

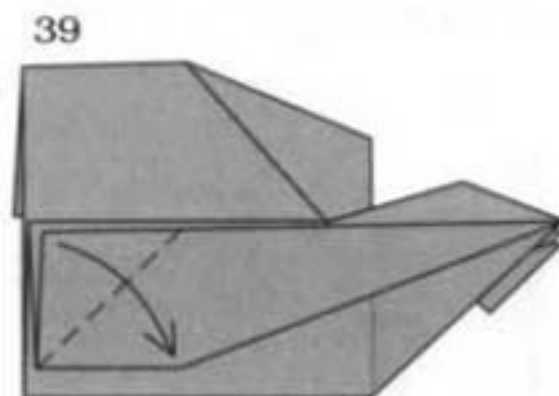

Fold the corner of the flap down.

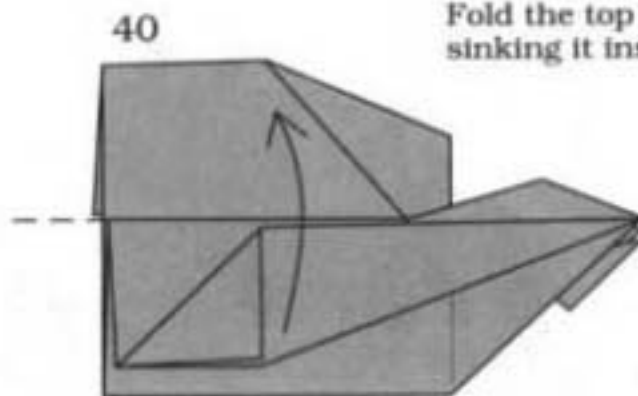

Fold the flap back up.

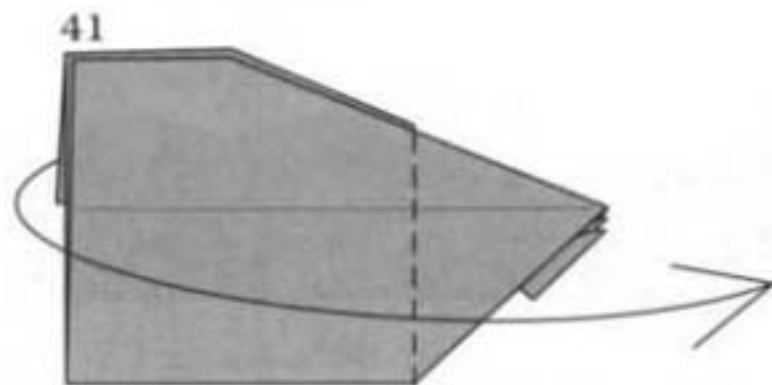

Fold both layers over to the right.

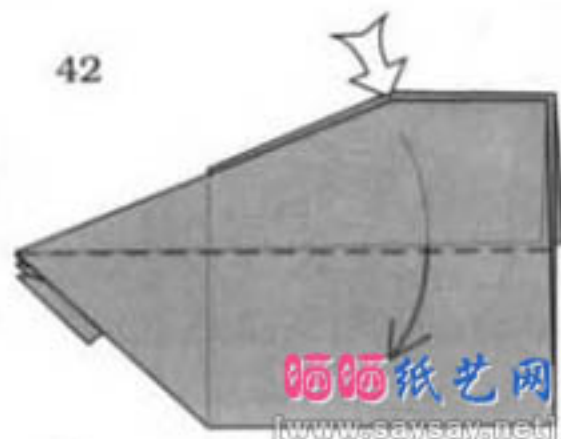

Repeat steps 37-40 on this side.

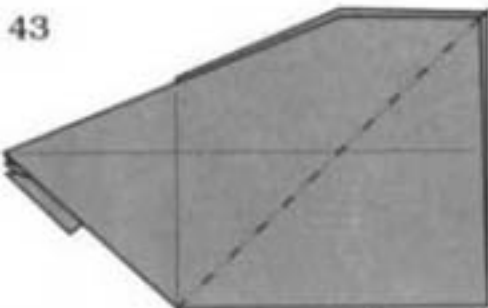

Reverse-fold the corner.

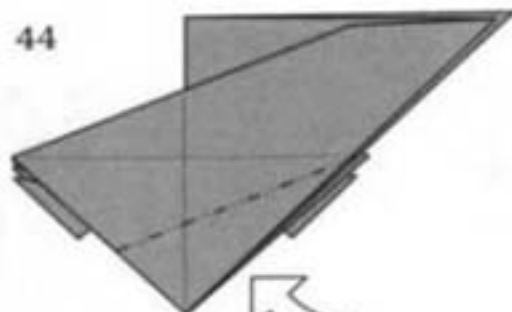

Sink the point.

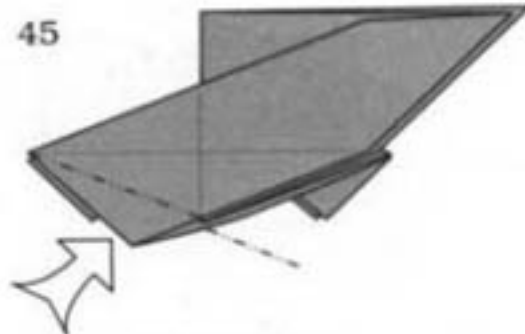

Sink the point.

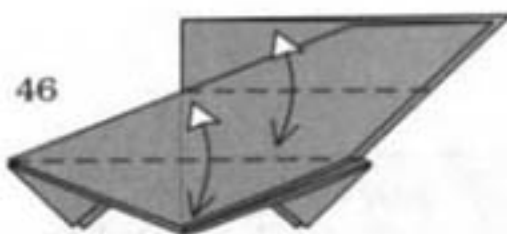

Fold and unfold.

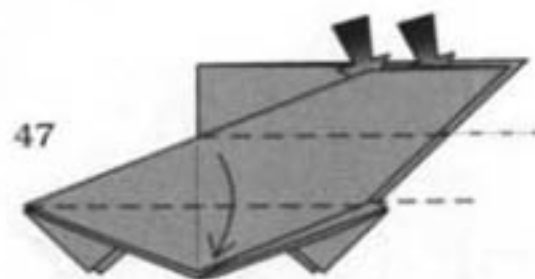

Pleat all layers individually, so that the two flaps remain separated.

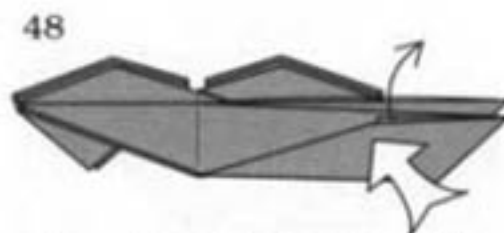

Grasp the original corner of the square that is inside the near flap and pull it entirely out of the flap.



Fold down. The paper will not lie flat.

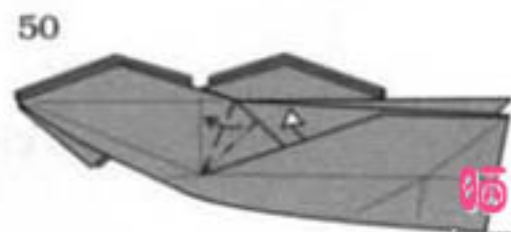

Crimp the paper toward the middle of the model and pull out the paper where shown.



Close the flap back up.

晒晒纸艺网

[www.saysay.net]

52



Fold both flaps  
over to the left.

54



Fold one flap over to the left.

56



Like this. Turn the paper  
over from side to side.

58

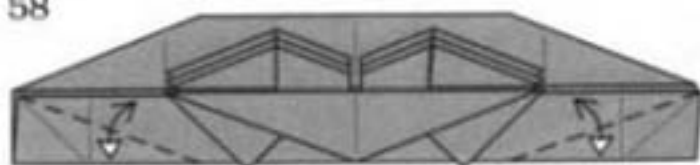

Fold and unfold.

53

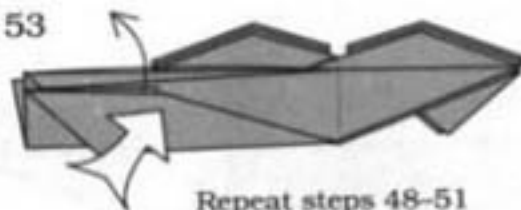

Repeat steps 48-51  
on this side.

55

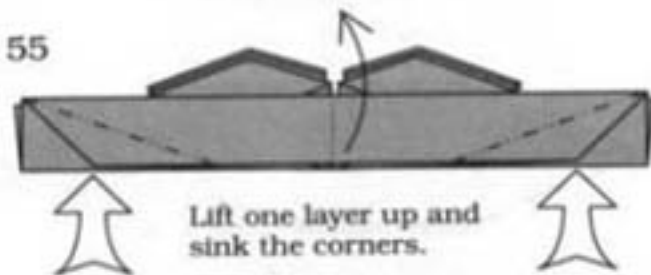

Lift one layer up and  
sink the corners.

57

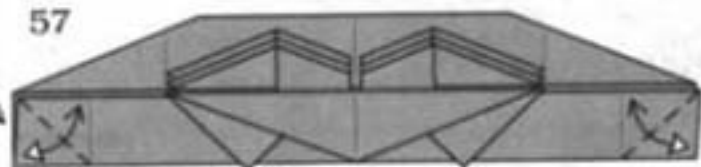

Fold and unfold.

59



Reverse-fold both corners.

晒晒纸艺网  
[www.saysay.net]



Reverse-fold both corners.

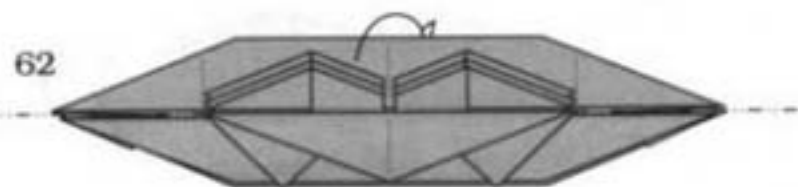

Mountain-fold the top flap behind.



Reverse-fold the other two such flaps.



Like this. Turn the paper over.

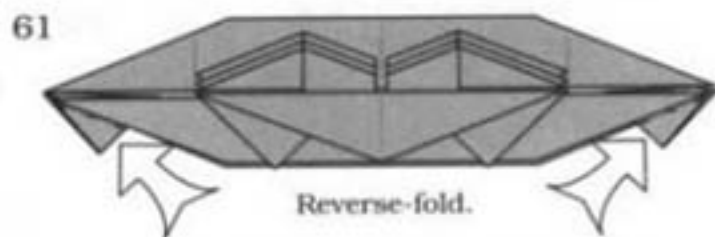

Reverse-fold.



Reverse-fold two single-ply flaps up from inside the model.

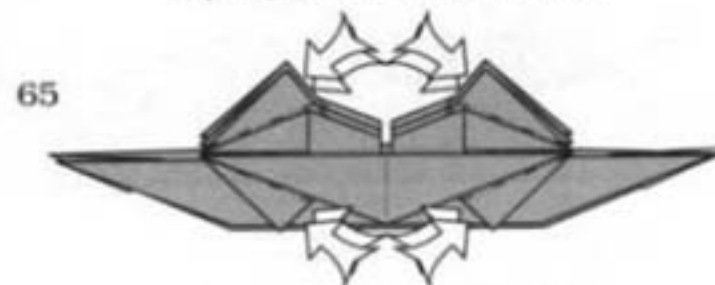

Reverse-fold four corners.

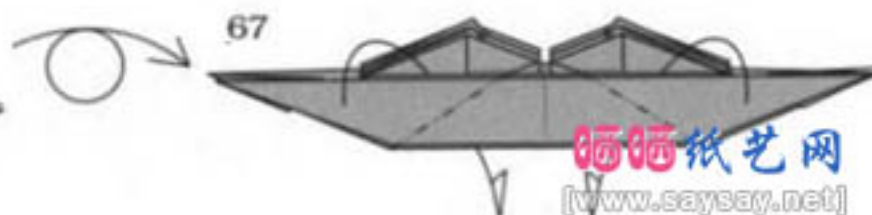

Mountain-fold the two flaps downward.

68

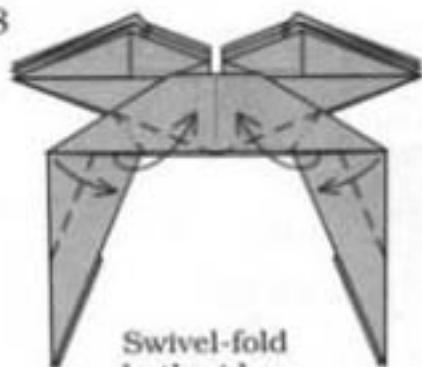

Swivel-fold  
both sides.

71

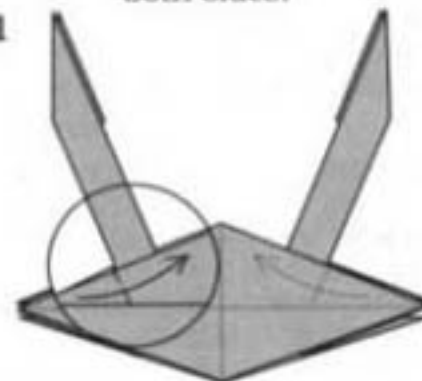

Valley-fold the top pair of  
hidden points to the center line.

74

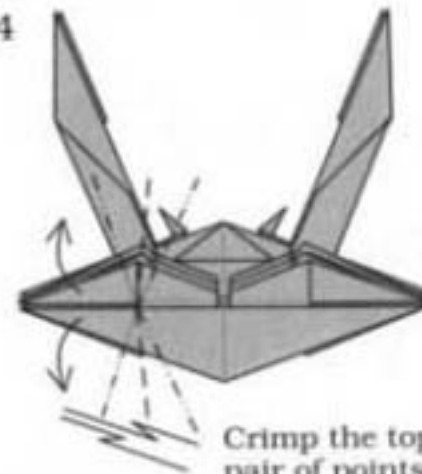

Crimp the top  
pair of points  
asymmetrically.

69

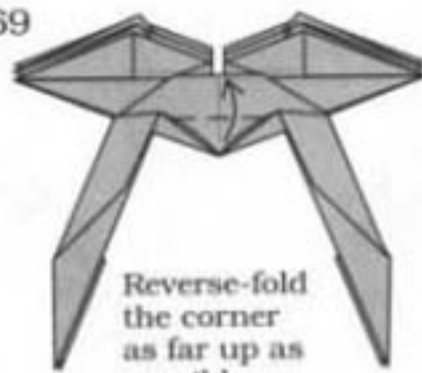

Reverse-fold  
the corner  
as far up as  
possible.

72

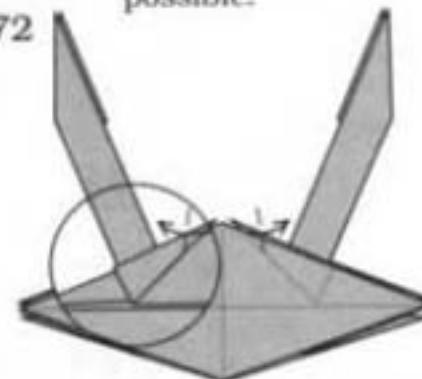

Valley-fold the tips of those  
same points upward.

75

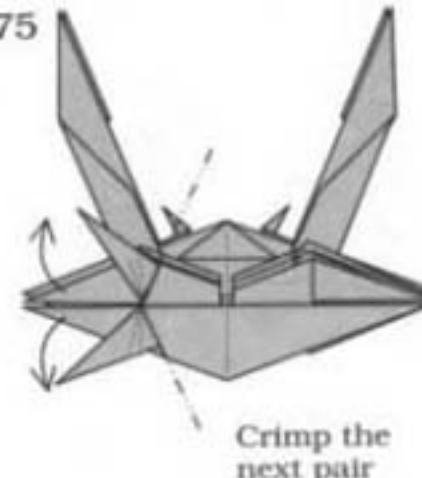

Crimp the  
next pair  
of points.

70

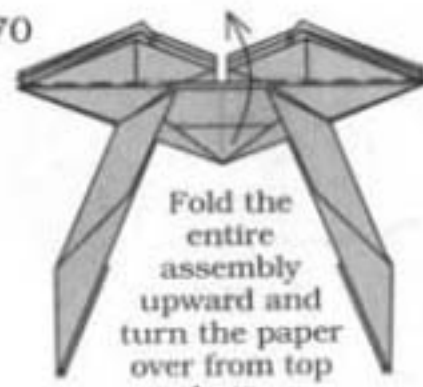

Fold the  
entire  
assembly  
upward and  
turn the paper  
over from top  
to bottom.

73

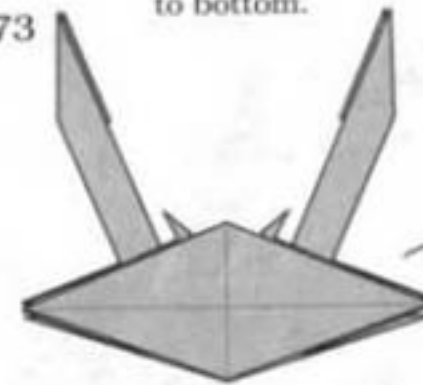

Like this. Turn the paper  
over from side to side.

76



Like this. Repeat steps  
74-75 on the right.

晒晒纸艺网  
[www.saysay.net]

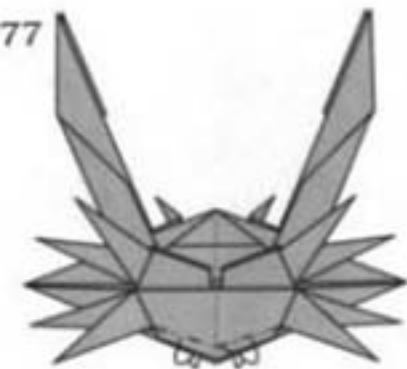

Mountain-fold the layers at the bottom.

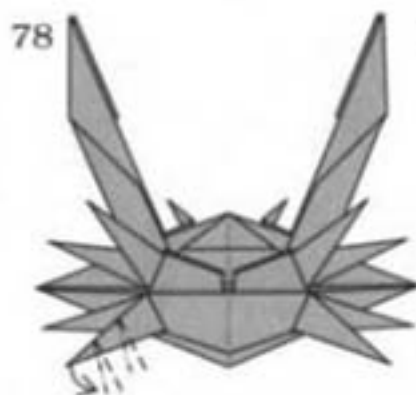

Crimp all of the legs (only one is shown here).

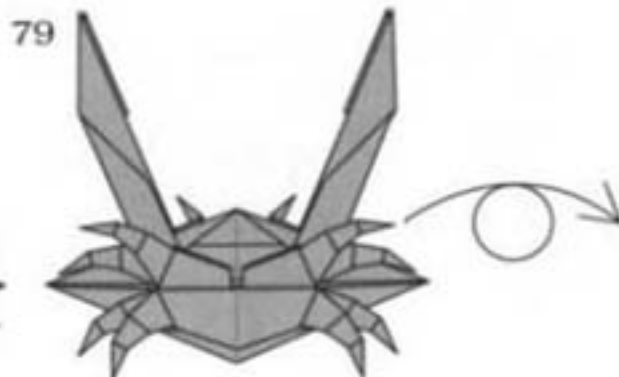

Like this. Turn the model over.

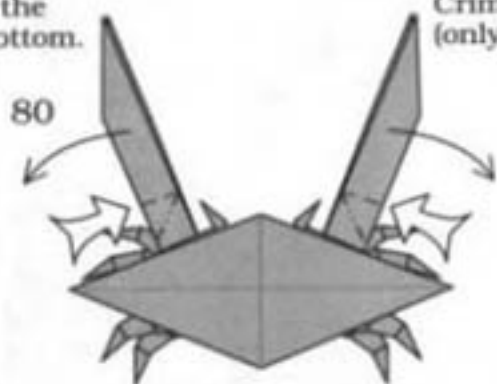

Crimp the two long flaps outward.

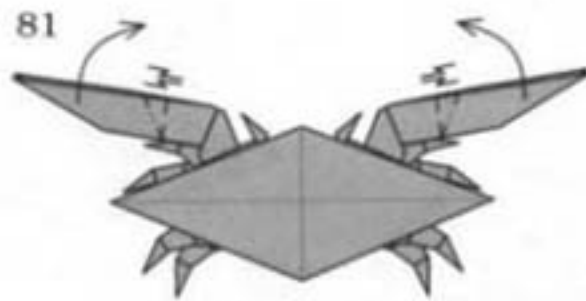

Crimp again.

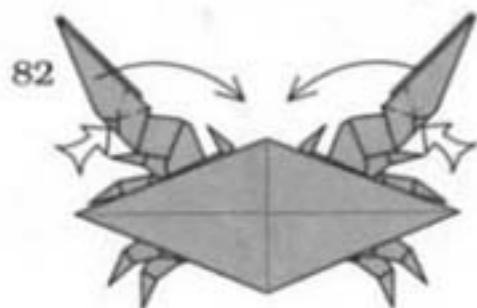

Squash-fold the claws toward each other.

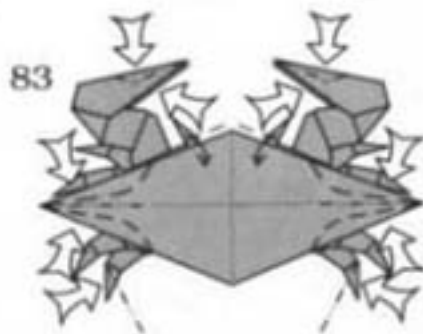

Pinch the tips of the claws and the spines on the sides of the shell. Shape the body to be three-dimensional, and squash-fold the bottommost pair of legs.



晒晒纸艺网  
[www.samsay.net]  
Blue Crab